

# Super Copa Absoluta 10/10/2015 Irun Sen F -48

Competidores: 5

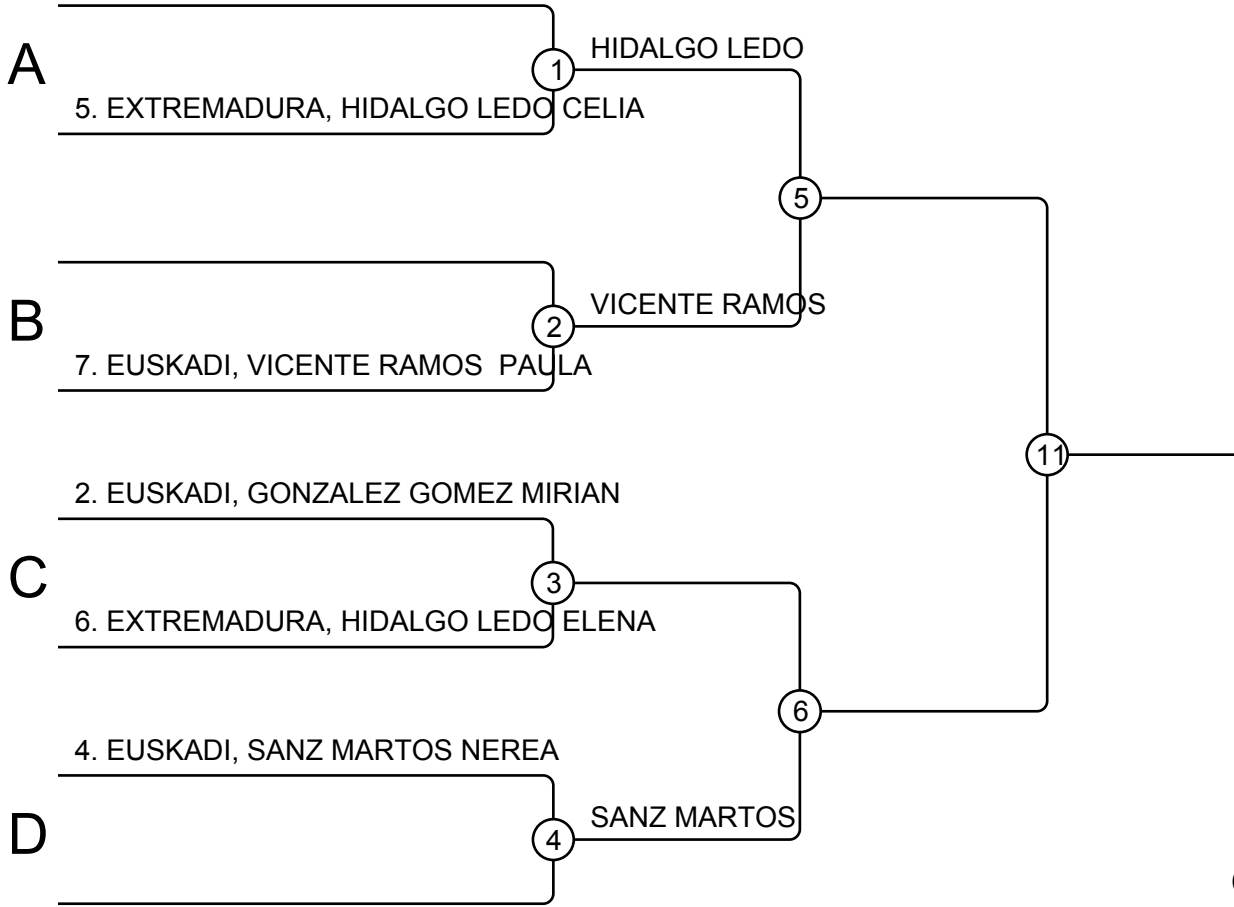

**Clasificación**

Pos.	Nombre
1	
2	
3	
3	
5	
5	
7	
7	

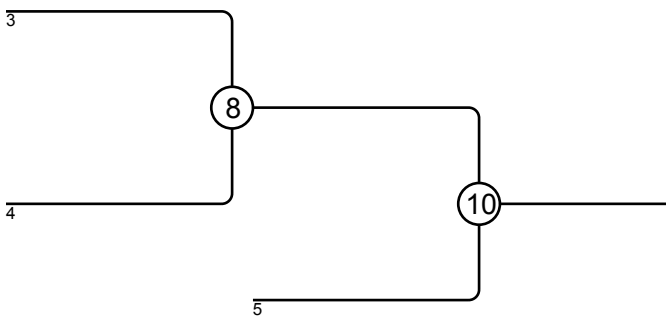
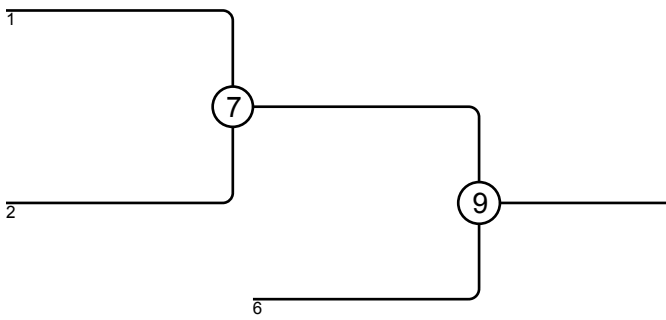

# Super Copa Absoluta 10/10/2015 Irun Sen F -52

Competidores: 10

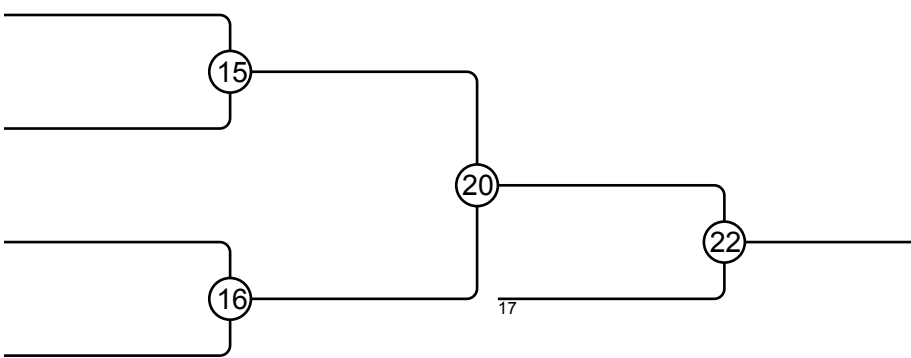
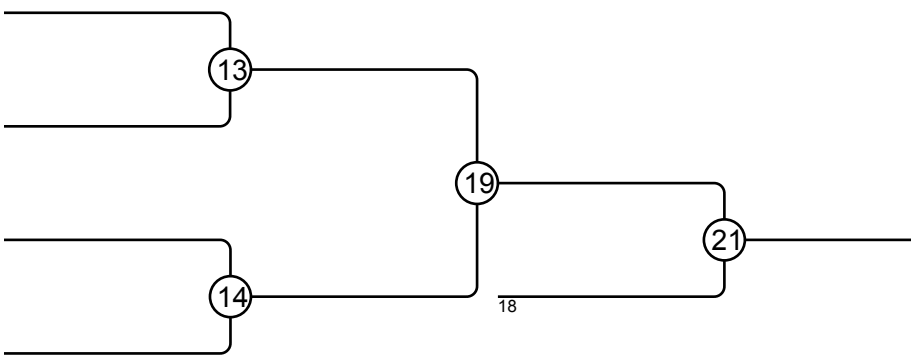
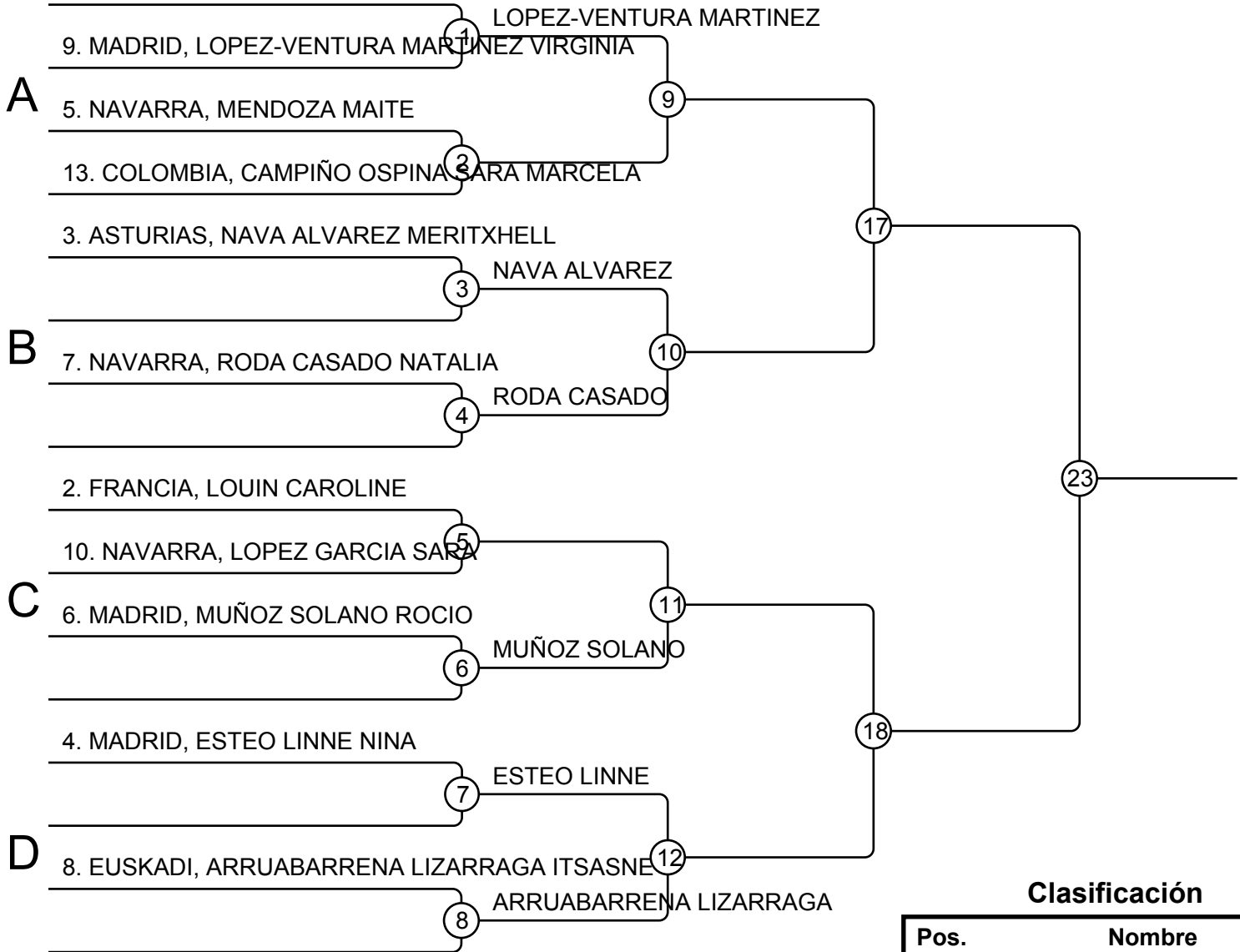

## Clasificación

Pos.	Nombre
1	
2	
3	
3	
5	
5	
7	
7	

# Super Copa Absoluta 10/10/2015 Irun Sen F -57

Competidores: 11

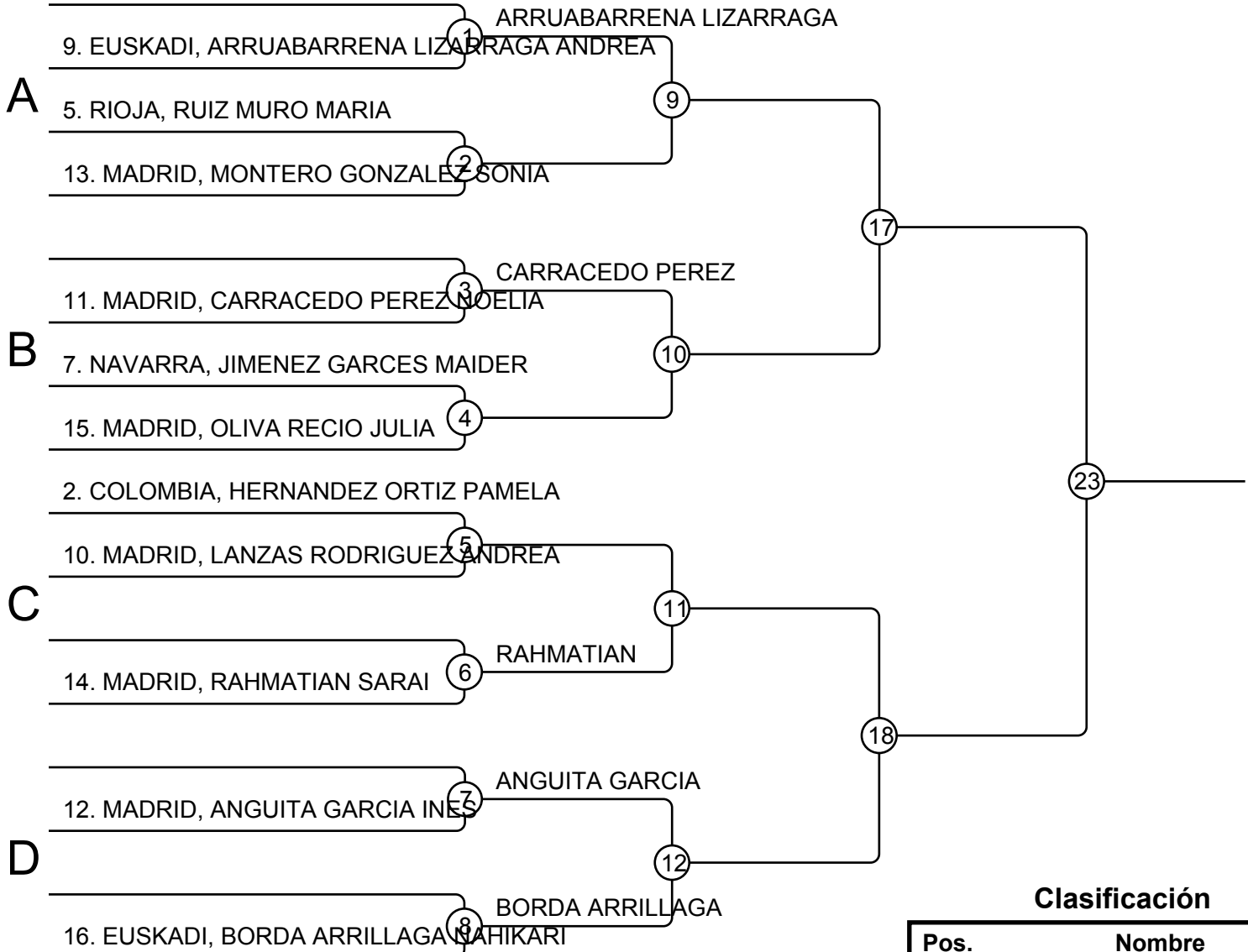

## Clasificación

Pos.	Nombre
1	
2	
3	
3	
5	
5	
7	
7	

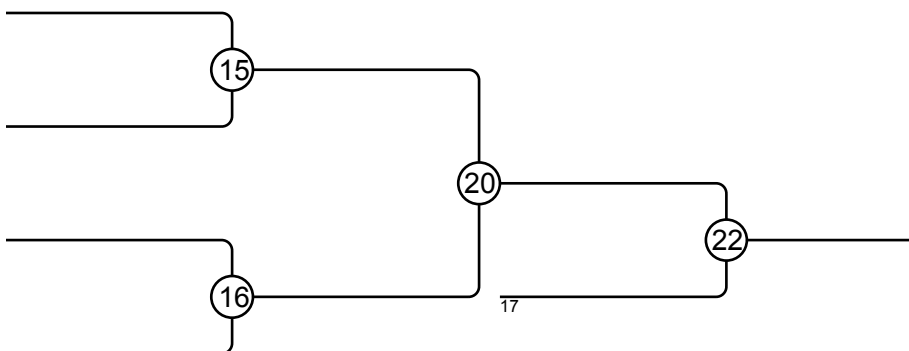
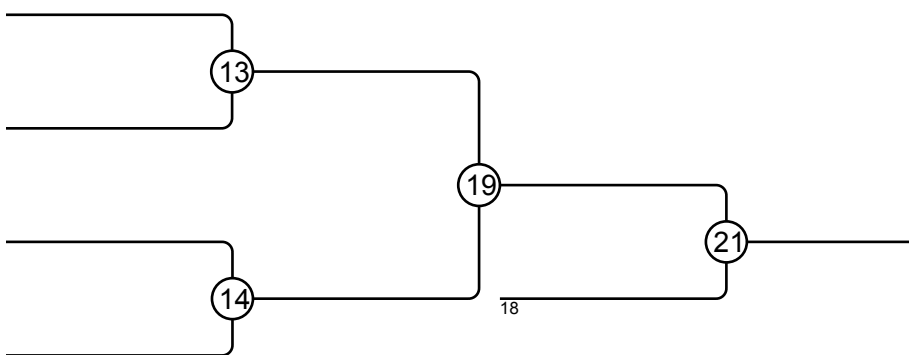

# Super Copa Absoluta 10/10/2015 Irun Sen F -63

Competidores: 9

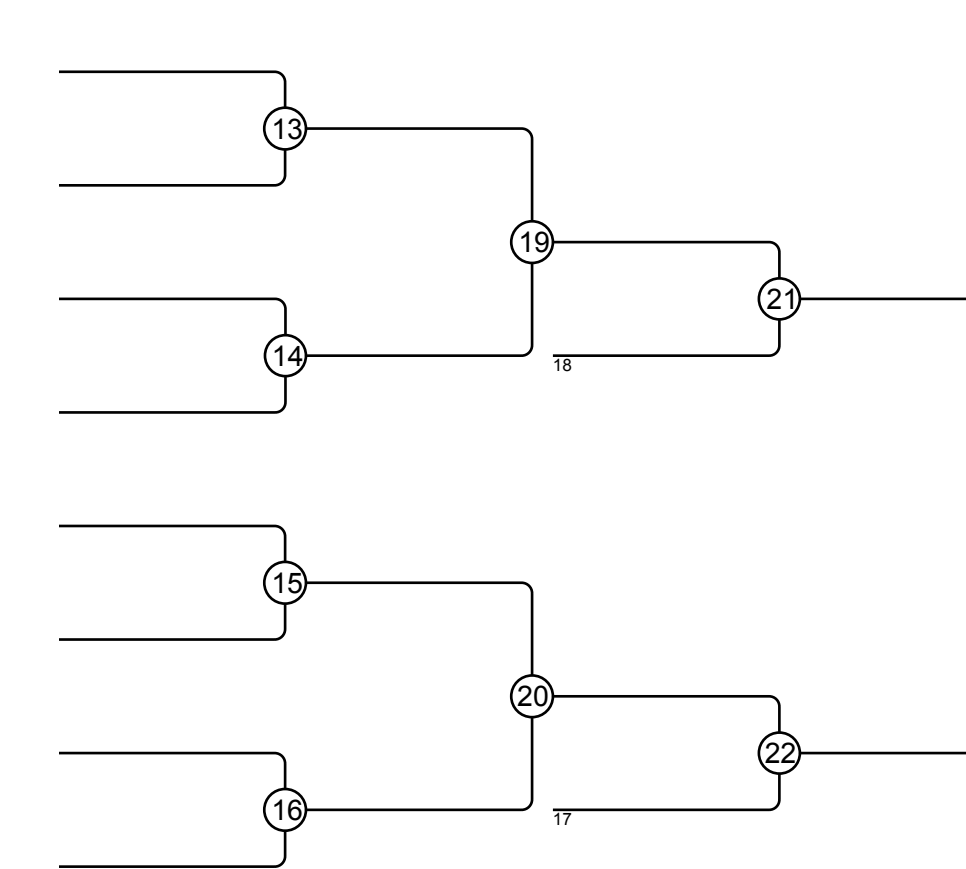
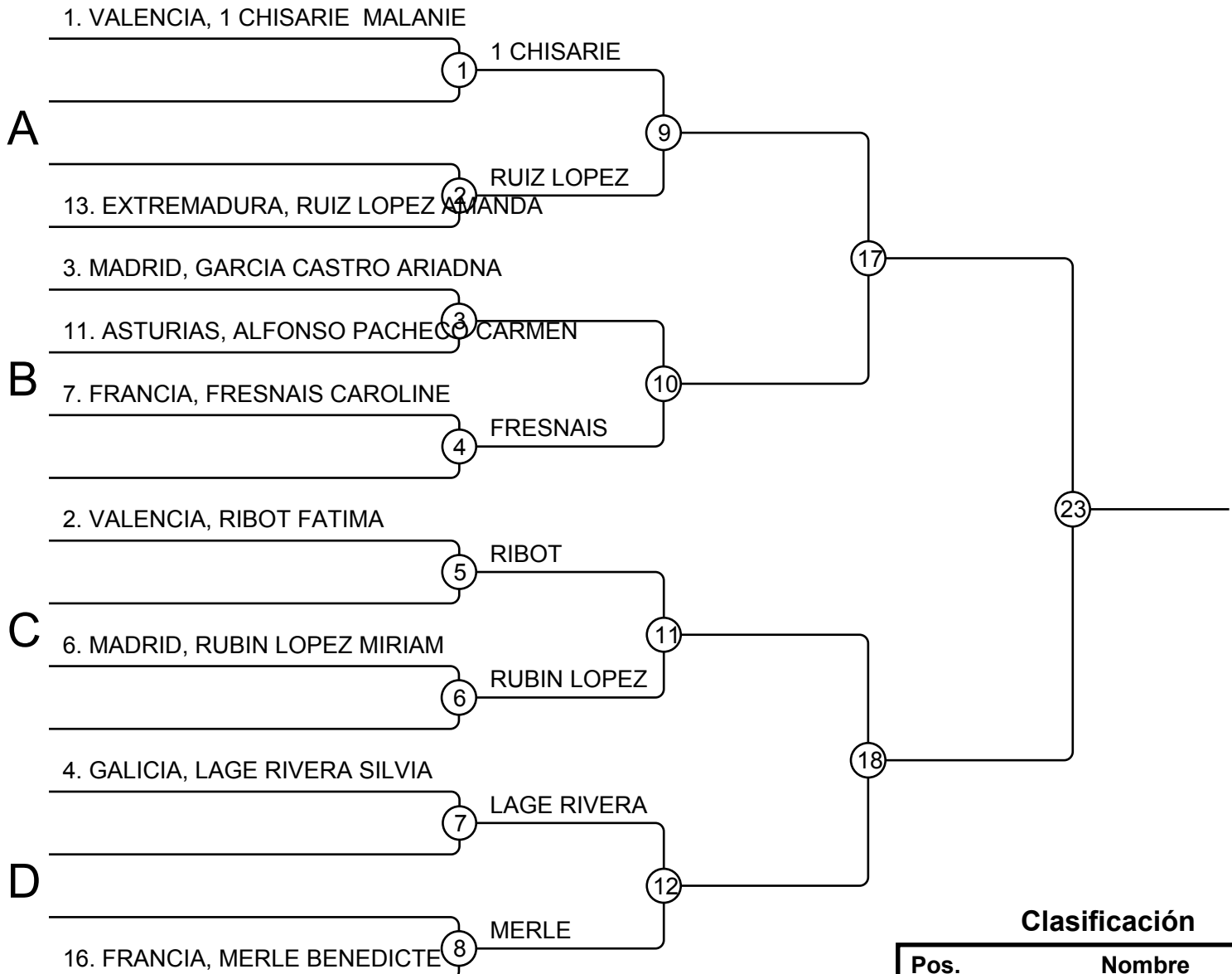

## Clasificación

Pos.	Nombre
1	
2	
3	
3	
5	
5	
7	
7	

# Super Copa Absoluta 10/10/2015 Irun Sen F -70

Competidores: 7

1. VALENCIA, 1 SERRANO GONZALEZ MARIA VICTORIA

A

1 SERRANO GONZALEZ

3. ASTURIAS, CORTINES HIERRO LYDIA

B

7. EUSKADI, ARRETXE URKIA NAHIKARI

2. EUSKADI, 2 LOPEZ CENTENO DIANA

C

6. CANTABRIA, LOPEZ LOPEZ ANGELA

4. EUSKADI, MUGURUZA LECEA NEKANE

D

8. ASTURIAS, FERNANDEZ GOMEZ CRISTINA

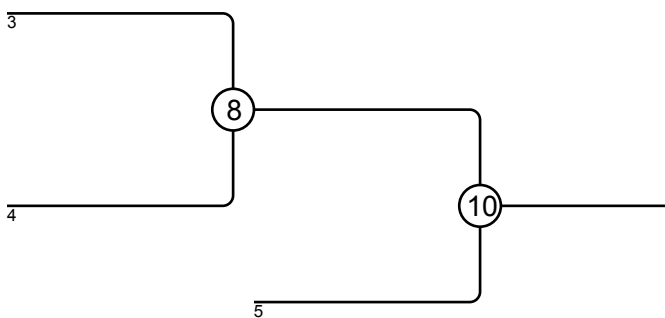
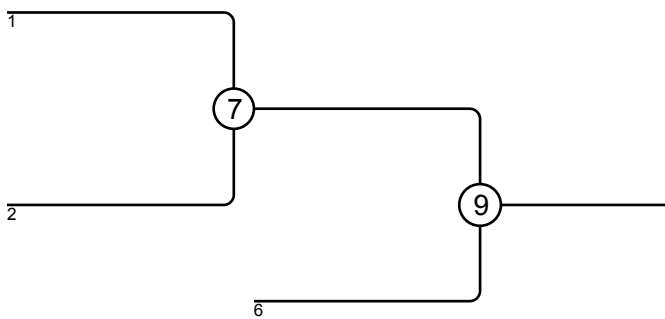

11

## Clasificación

Pos.	Nombre
1	
2	
3	
3	
5	
5	
7	
7	

# Super Copa Absoluta 10/10/2015 Irun Sen F -78

Competidores: 3

## Competidores

Nº	Nombre	Club	1	2	3	Victs.	Pts.	Pos.
1	RODRIGUEZ GONZALEZ PATRICIA	MADRID						
2	MARTINEZ BORREGUERO PAULA	MADRID						
3	RODRIGUEZ GARCIA MARIA	ASTURIAS						

## Combates

Comb.	Blanco			Azul	Resultado	Tiempo
1	RODRIGUEZ GONZALEZ PATRICIA	1	2	MARTINEZ BORREGUERO PAULA		
2	RODRIGUEZ GONZALEZ PATRICIA	1	3	RODRIGUEZ GARCIA MARIA		
3	MARTINEZ BORREGUERO PAULA	2	3	RODRIGUEZ GARCIA MARIA		

## Clasificación

Pos.	Nombre
1	
2	
3	

# Super Copa Absoluta 10/10/2015 Irun Sen F +78

Competidores: 2

## Competidores

Nº	Nombre	Club	1	2	1	2	1	2	Victs.	Pts.	Pos.
1	SALDARRIAGA QUINTERO ESTEFANIA	COLOMBIA									
2	PEREZ CEATHAYSA	CANARIAS									

## Combates

Comb.	Blanco	Azul	Resultado	Tiempo
1	SALDARRIAGA QUINTERO ESTEFANIA	2 PEREZ CEATHAYSA		
2	SALDARRIAGA QUINTERO ESTEFANIA	2 PEREZ CEATHAYSA		
3	SALDARRIAGA QUINTERO ESTEFANIA	2 PEREZ CEATHAYSA		

## Clasificación

Pos.	Nombre
1	
2	

# Super Copa Absoluta 10/10/2015 Irun Sen M -60

Competidores: 17

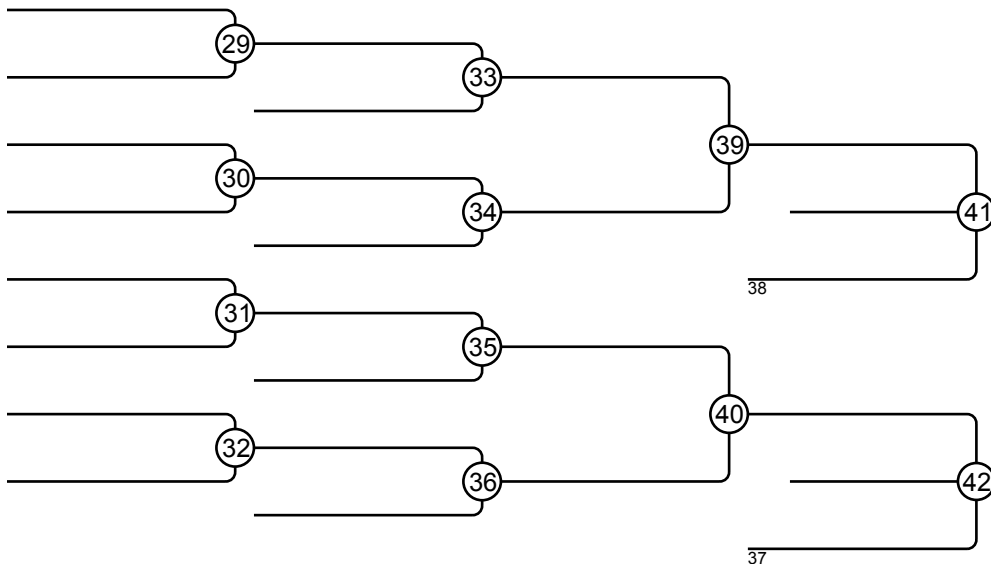
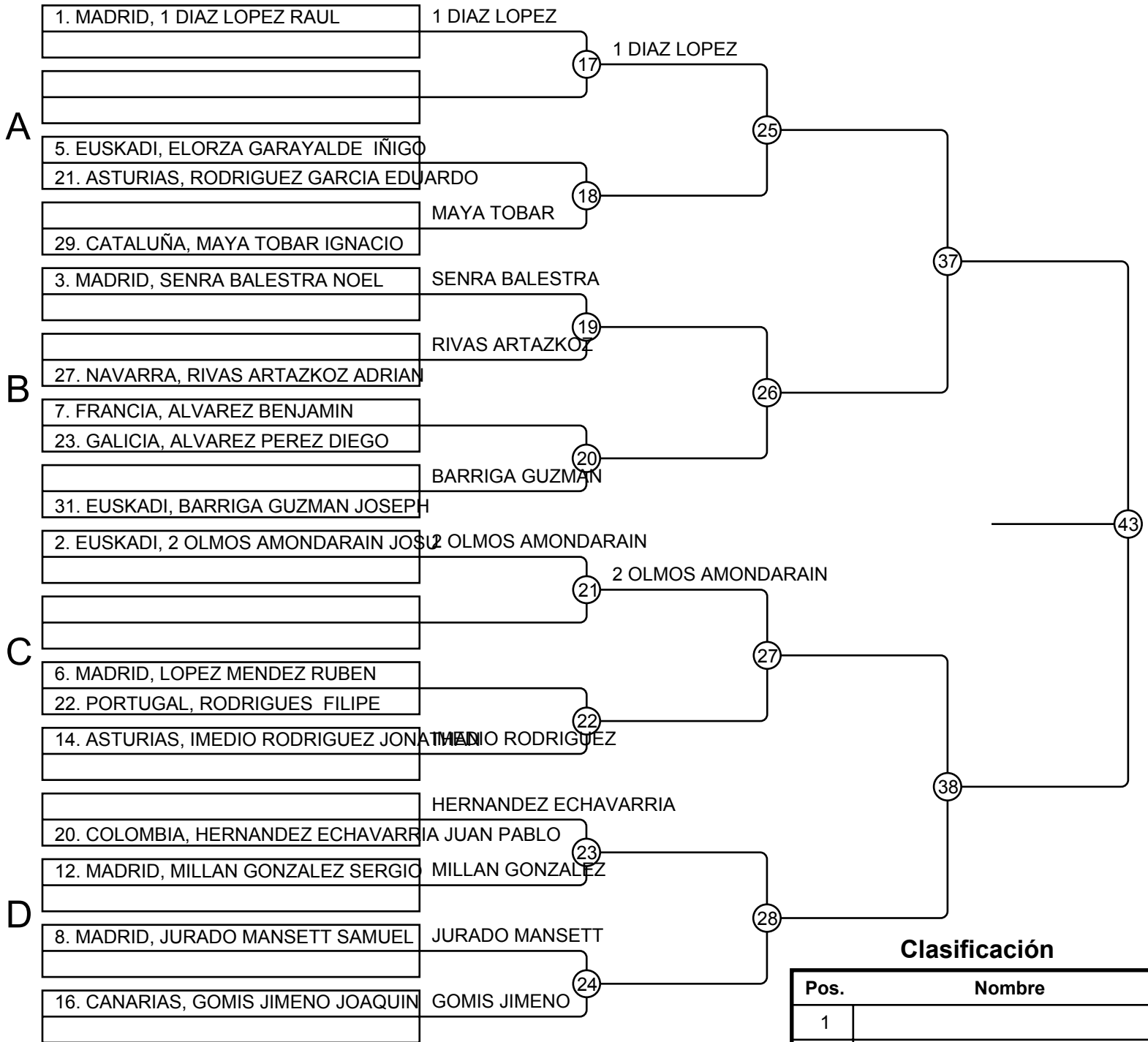



# Super Copa Absoluta 10/10/2015 Irun Sen M -66 (1/3)

Competidores: 34

A

B

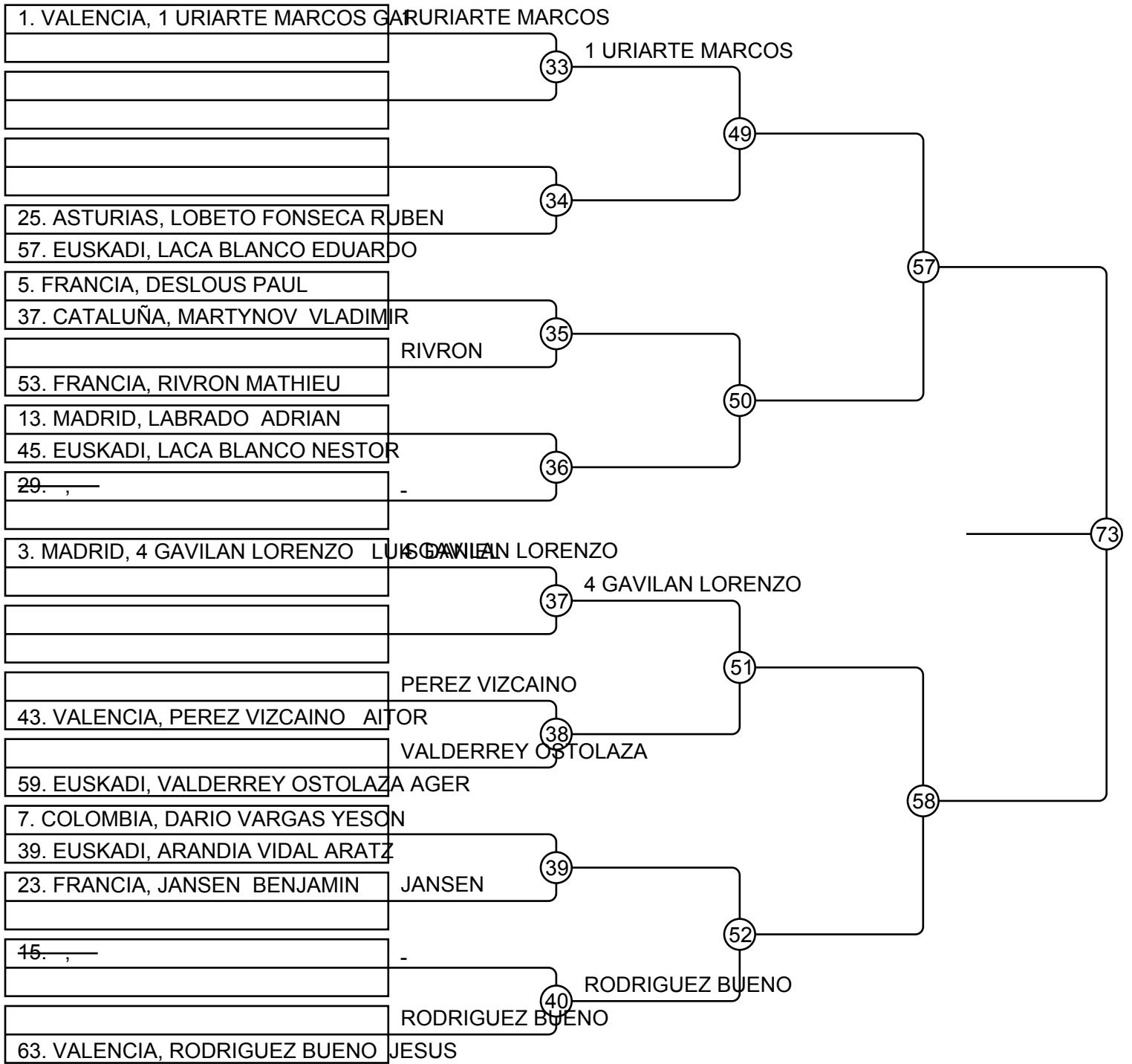

# Super Copa Absoluta 10/10/2015 Irun Sen M -66 (2/3)

Competidores: 34

C

D

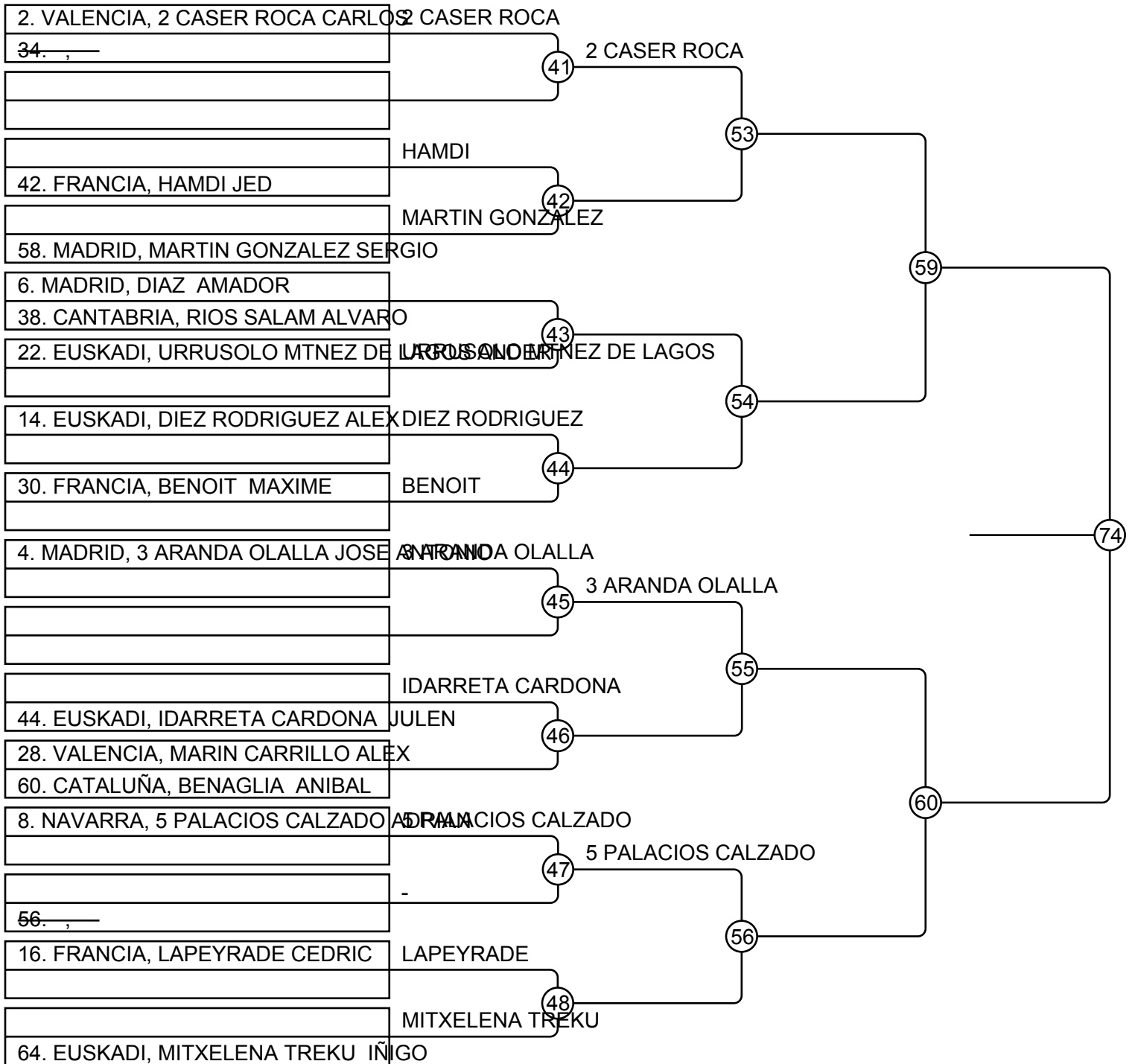

# Super Copa Absoluta 10/10/2015 Irun Sen M -66 (3/3)

Competidores: 34

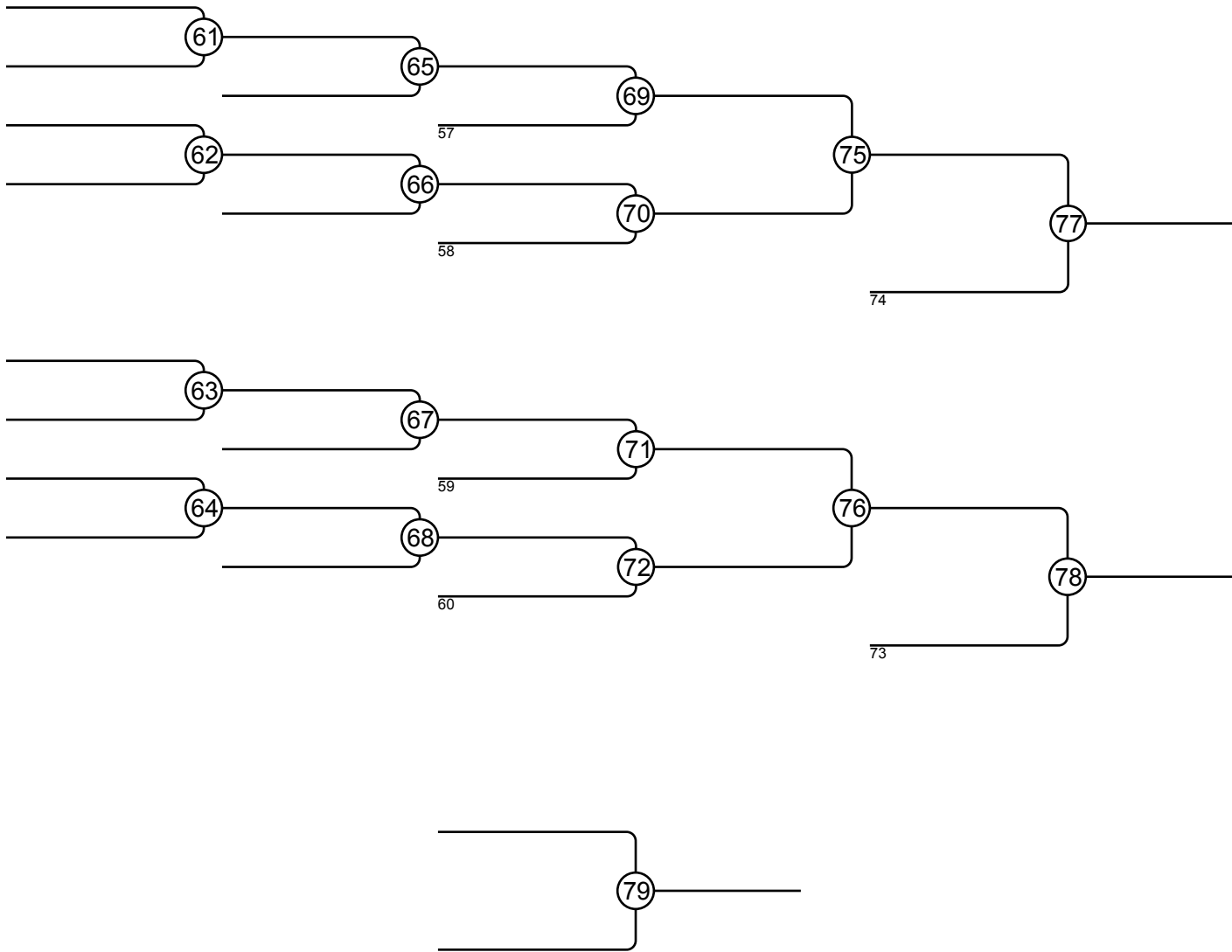

## Clasificación

Pos.	Nombre
1	
2	
3	
3	
5	
5	
7	
7	

# Super Copa Absoluta 10/10/2015 Irun Sen M -73 (1/3)

Competidores: 33

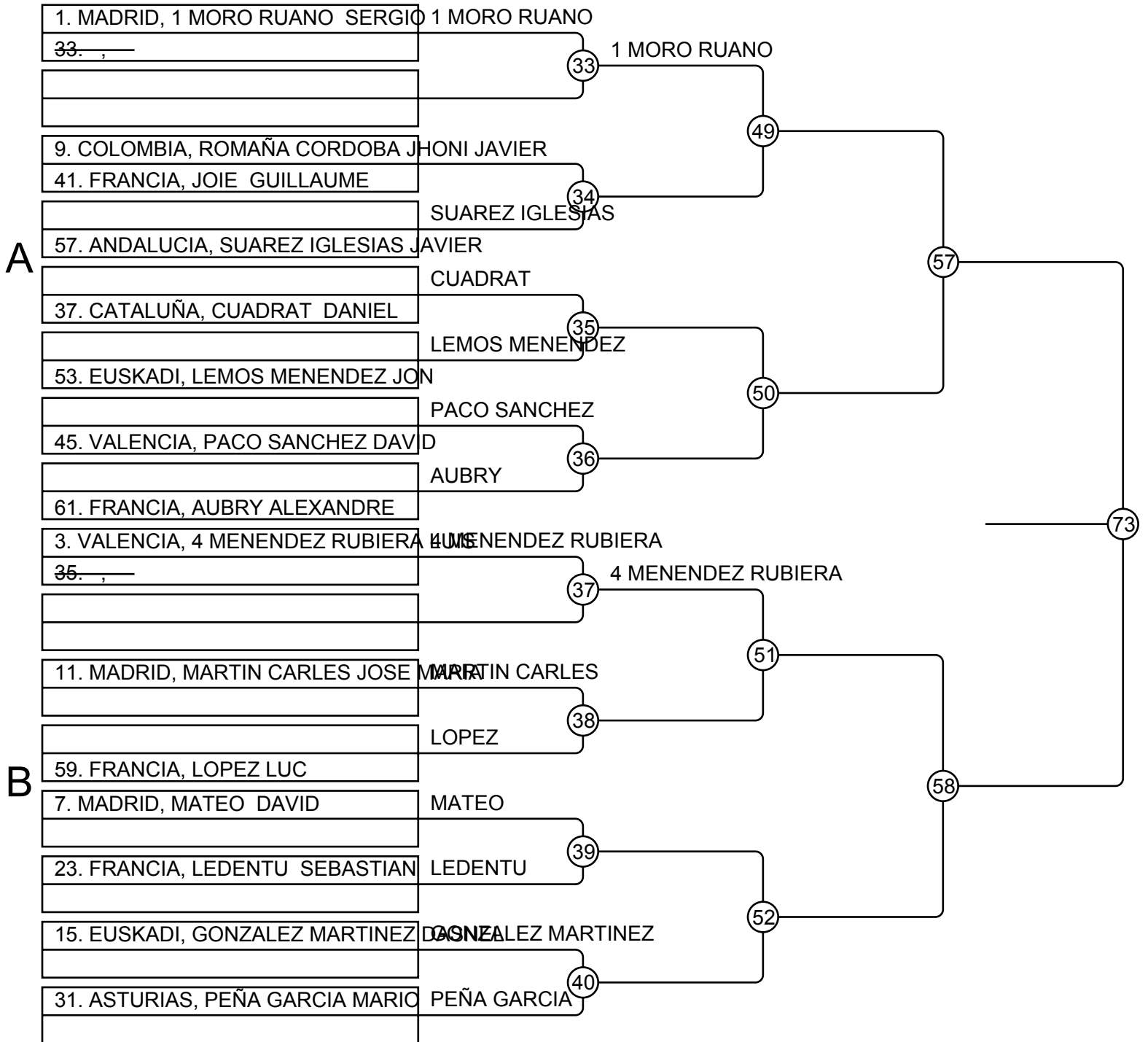

# Super Copa Absoluta 10/10/2015 Irun Sen M -73 (2/3)

Competidores: 33

C

D

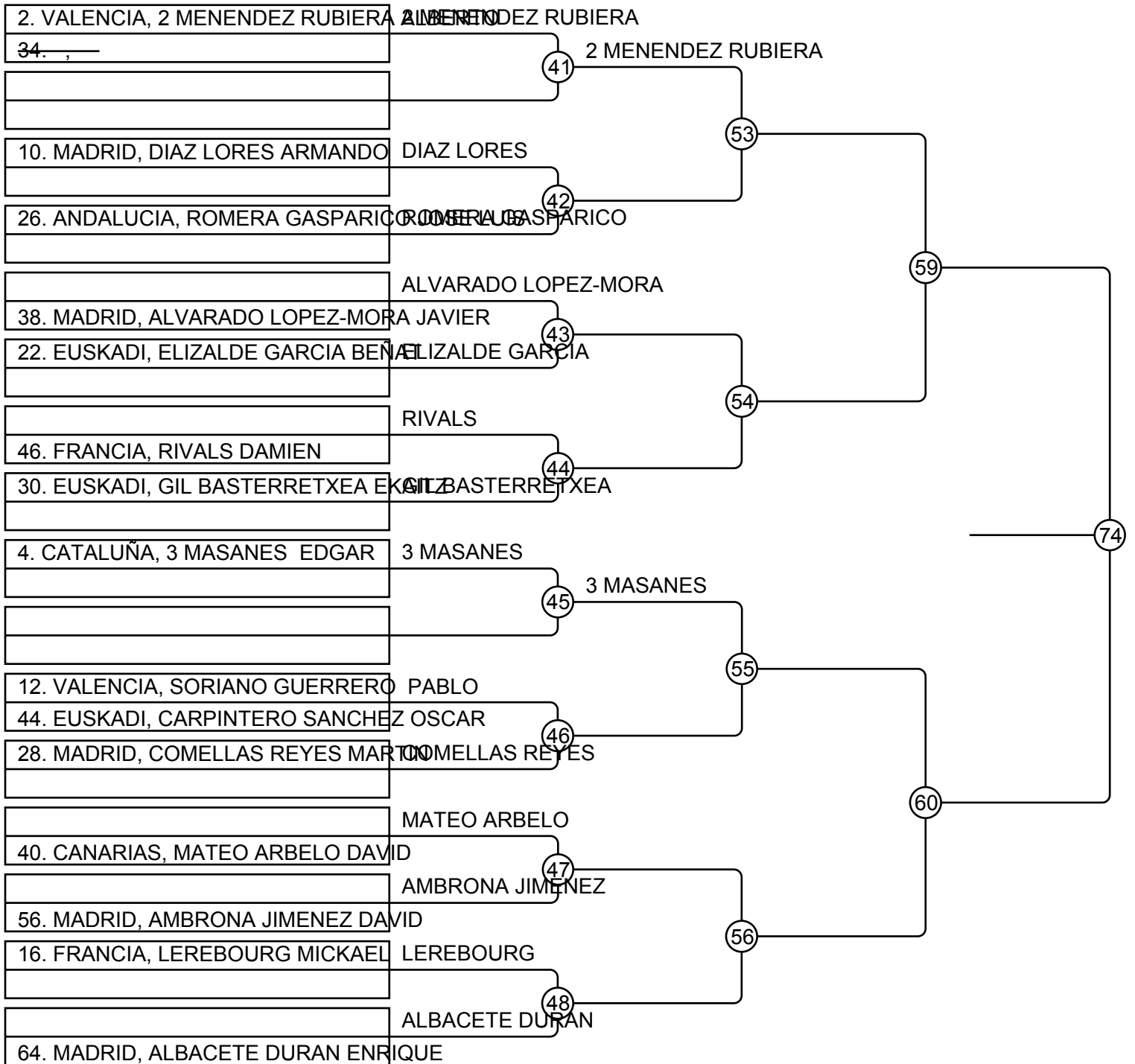

# Super Copa Absoluta 10/10/2015 Irun Sen M -73 (3/3)

Competidores: 33

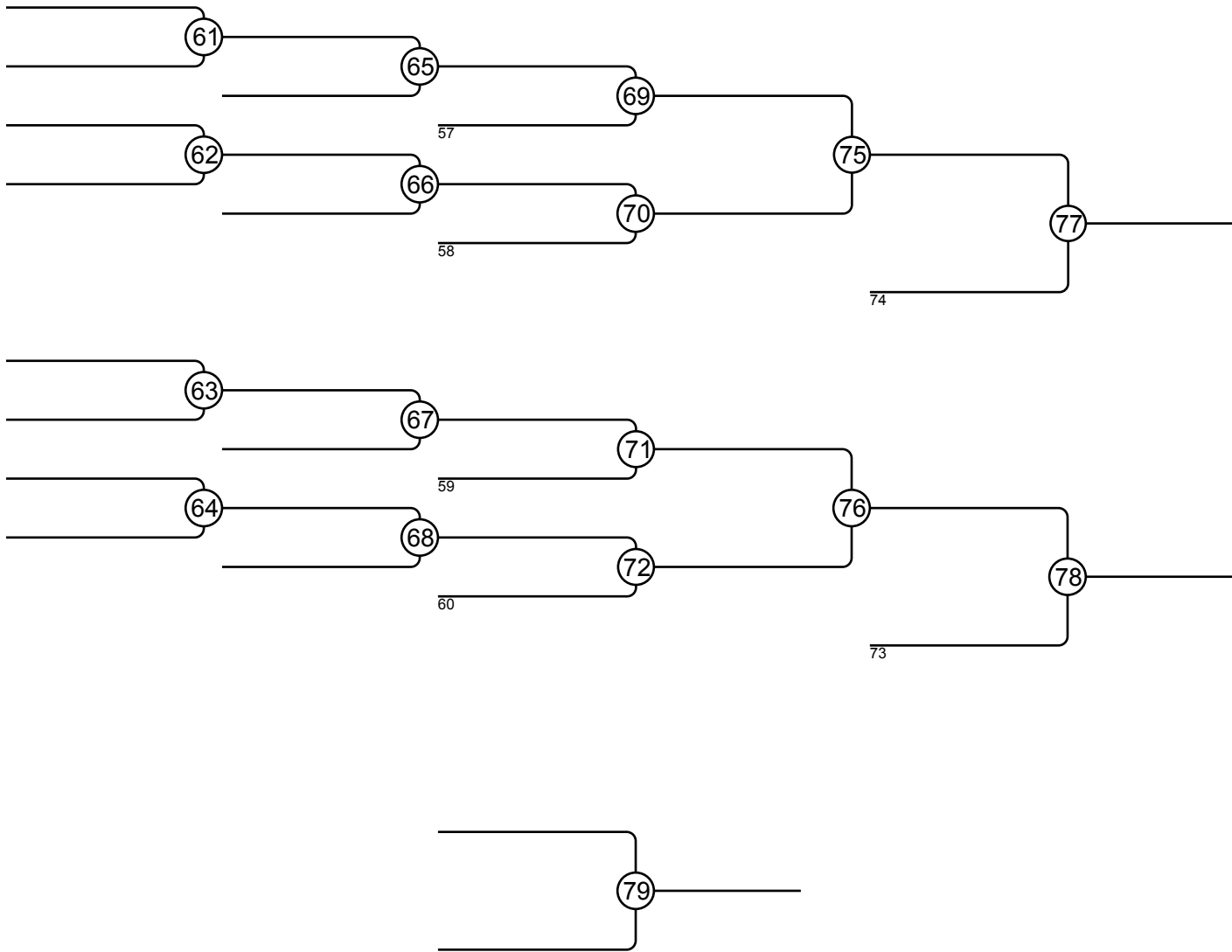

## Clasificación

Pos.	Nombre
1	
2	
3	
3	
5	
5	
7	
7	

# Super Copa Absoluta 10/10/2015 Irun Sen M -81 (1/3)

Competidores: 33

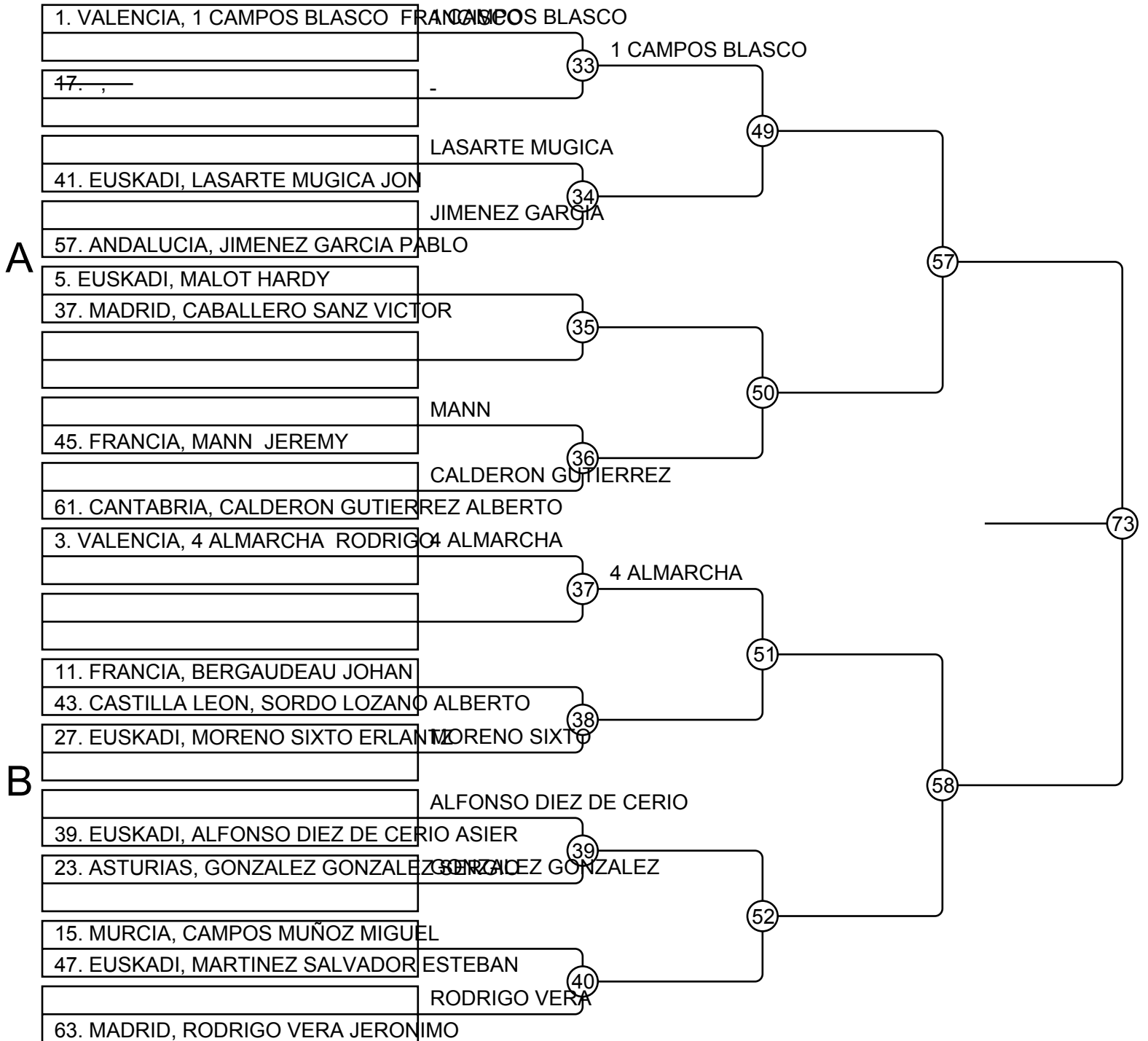

# Super Copa Absoluta 10/10/2015 Irun Sen M -81 (2/3)

Competidores: 33

C

D

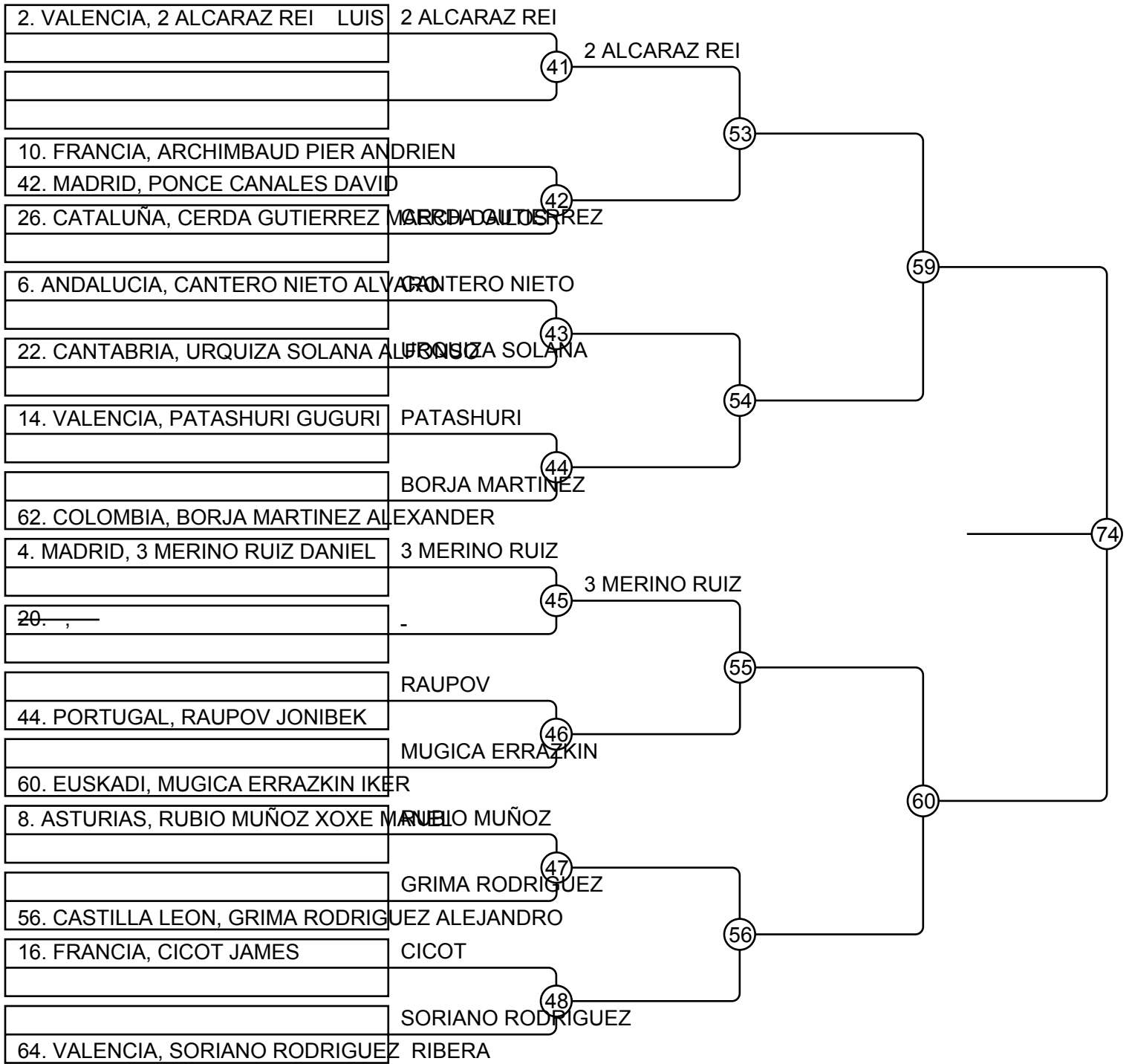



# Super Copa Absoluta 10/10/2015 Irun Sen M -81 (3/3)

Competidores: 33

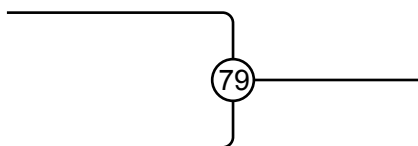
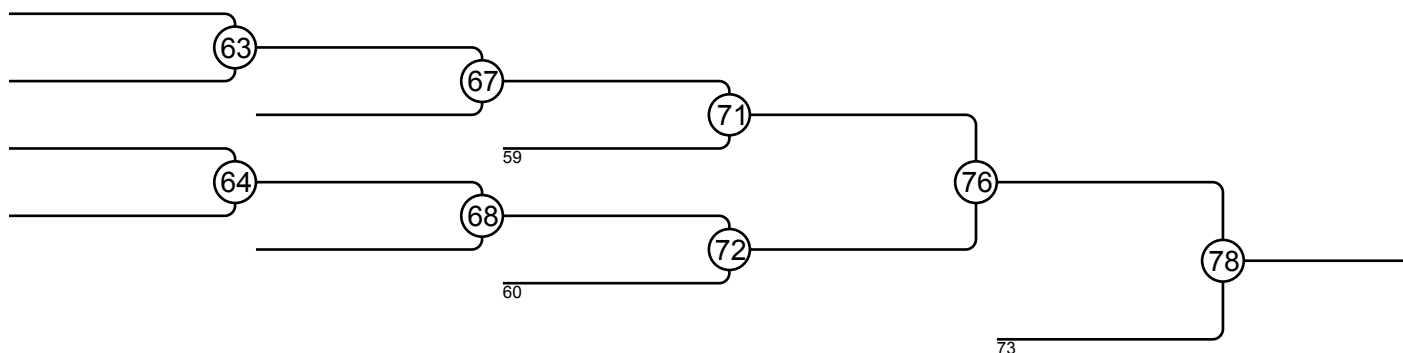
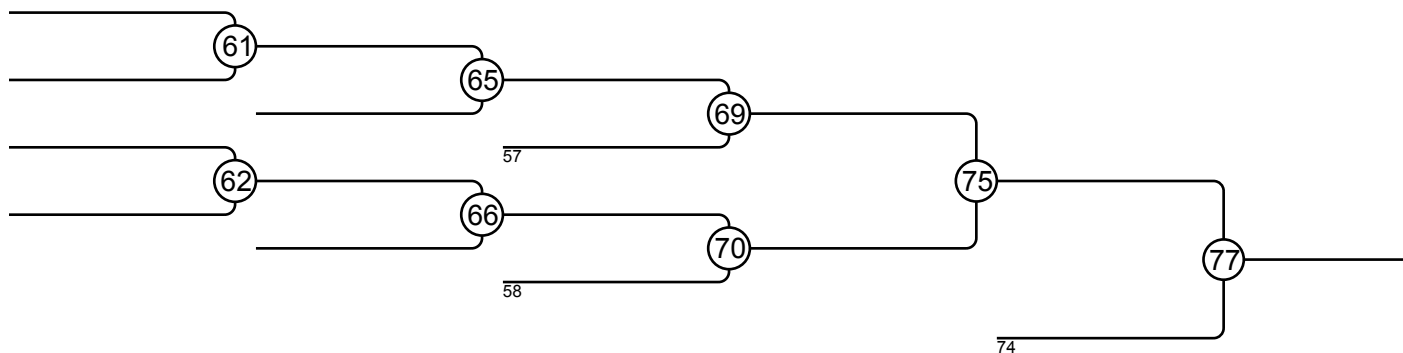

## Clasificación

Pos.	Nombre
1	
2	
3	
3	
5	
5	
7	
7	

# Super Copa Absoluta 10/10/2015 Irun Sen M -90

Competidores: 19

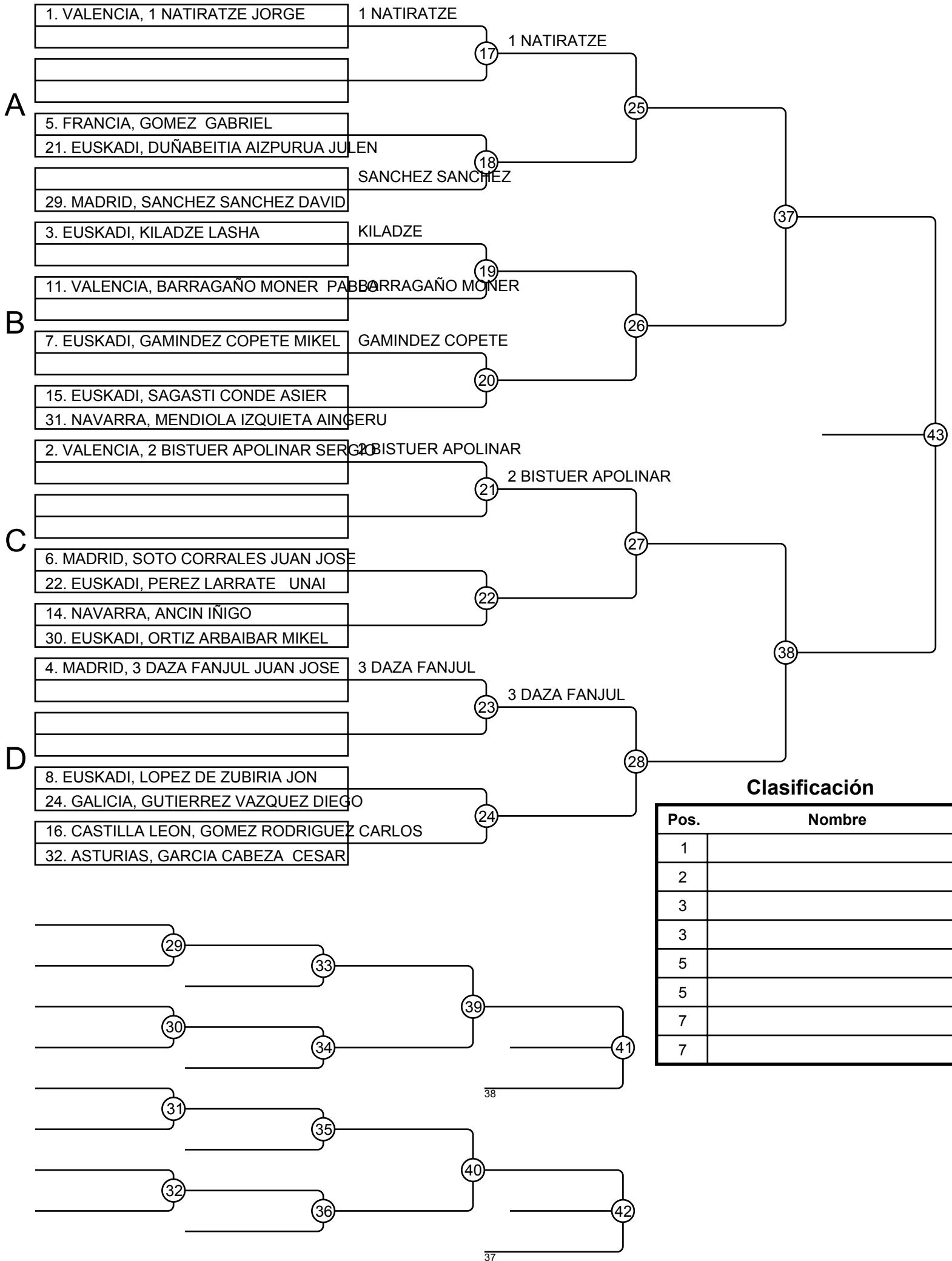

# Super Copa Absoluta 10/10/2015 Irun Sen M -100

Competidores: 8

1. VALENCIA, 1 EGUIGUREN BALERDI JOSU

A

5. CANARIAS, LUPICINO DIAZ

3. FRANCIA, DESFOUR ROMAIN

B

7. EUSKADI, INTXAURRAGA ANTON BOSCO

2. NAVARRA, 2 GERBOLES LOPEZ IÑIGO

C

6. COLOMBIA, MARTINEZ OMAR

4. VALENCIA, BENAZCO ANGEL DANIEL

D

8. PORTUGAL, SANDUTA ANDREI

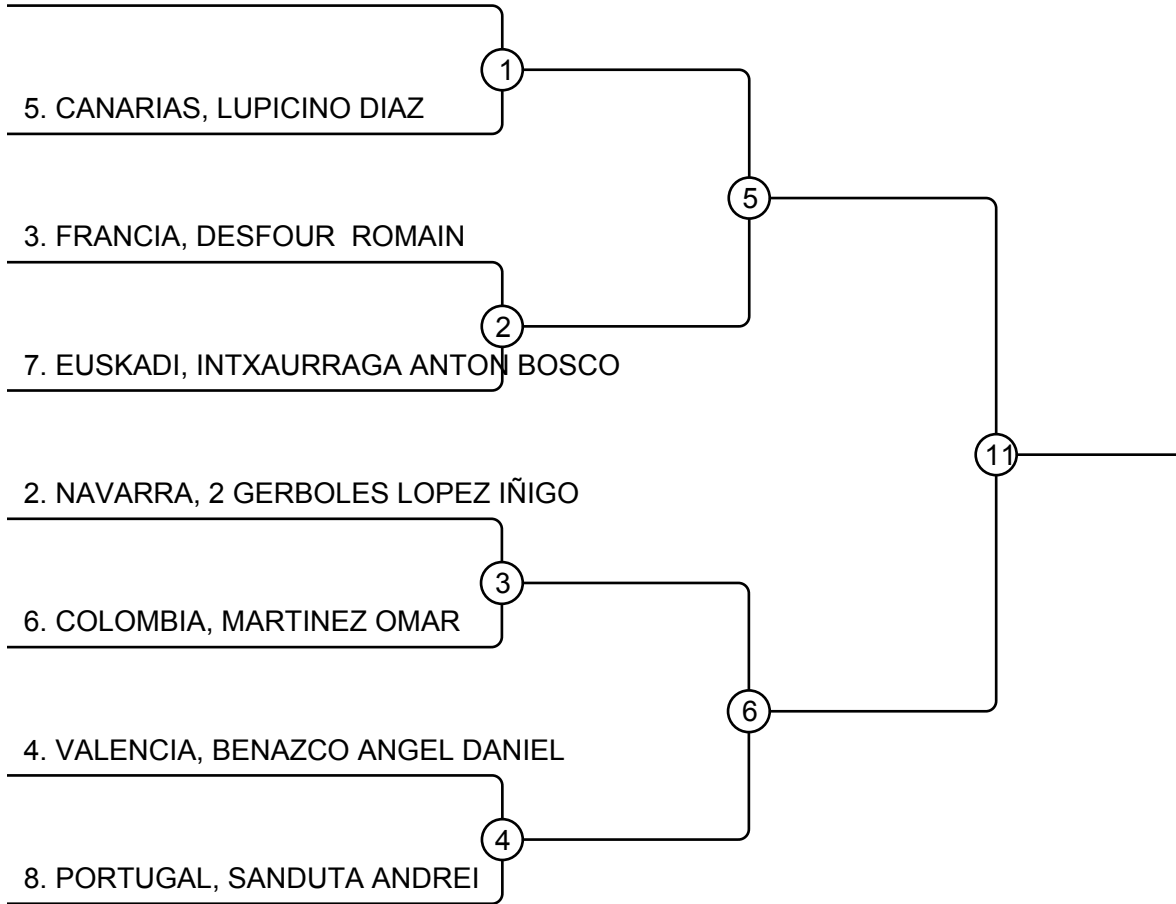

## Clasificación

Pos.	Nombre
1	
2	
3	
3	
5	
5	
7	
7	

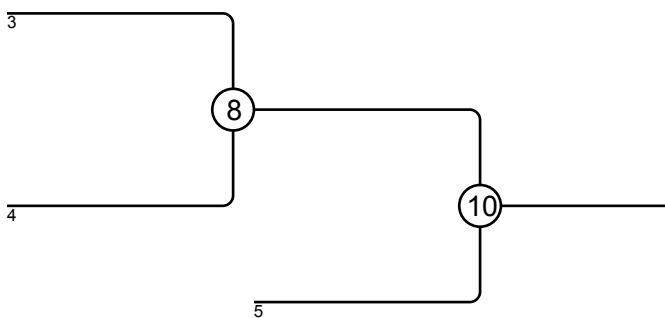
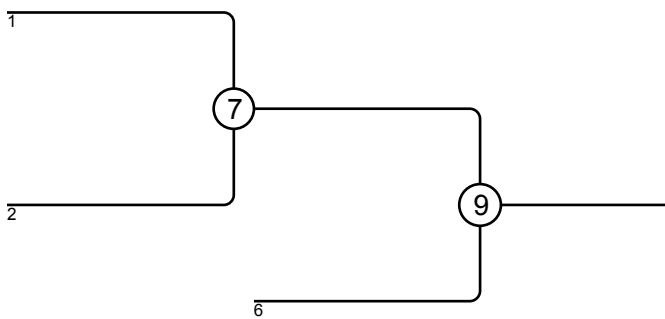

# Super Copa Absoluta 10/10/2015 Irun Sen M +100

Competidores: 3

## Competidores

Nº	Nombre	Club	1	2	3	Victs.	Pts.	Pos.
1	RAMON EIZAGUIRRE JULEN	EUSKADI						
2	FERNANDEZ RODRIGUEZ DAVID	VALENCIA						
3	PEREZ DURAN FRANCISCO	MADRID						

## Combates

Comb.	Blanco			Azul	Resultado	Tiempo
1	RAMON EIZAGUIRRE JULEN	1	2	1 FERNANDEZ RODRIGUEZ DAVID		
2	RAMON EIZAGUIRRE JULEN	1	3	PEREZ DURAN FRANCISCO		
3	1 FERNANDEZ RODRIGUEZ DAVID	2	3	PEREZ DURAN FRANCISCO		

## Clasificación

Pos.	Nombre
1	
2	
3	